

Varenummer: 20146B32562SW  
 Beskrivelse: E+G  
 Flange rørholder GN 146-B32-56-2-SW

## Mål

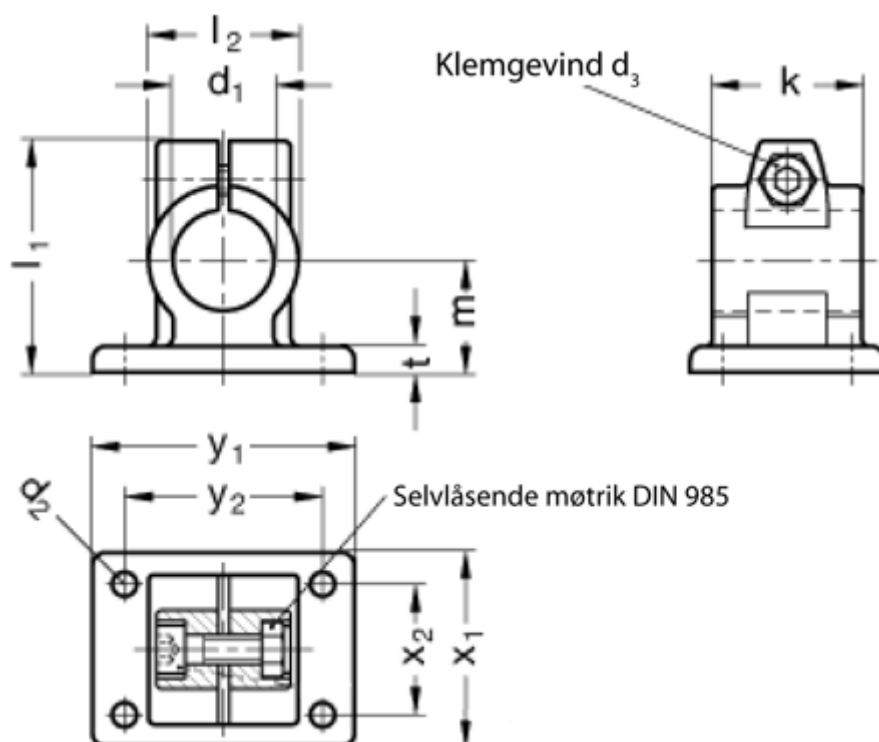

$d_1 = B32$	Vippehåndtag = GN 911-M10-40 skal bestilles separat
$d_2 = 8.5$	$x_1 = 78$
$d_3 = M10$	$x_2 = 52$
$k = 56$	$y_1 = 108$
$l_1 = 83$	$y_2 = 82$
$l_2 = 56$	
$m = 42$	
$t = 10$	